

## Bunker Discharge Machine

## Functional Description

The task of the Bunker Discharge Machine is to extract wet, cohesive, coarse or abrasive non free flowing bulk materials from bunkers, hoppers, bins, silos, stockpiles and dome type storages. The arms of the Bunker Discharge Machine rotate and reclaim bulk material from the bunker shelf onto a conveying system. The BDM can travel automatically and self-propel itself through a tunnel located under the stored bulk material. The rotating discharge arms convey the bulk material toward the opening in the center of the floor.

Bunker Discharge Machines are available in a variety of designs and configurations to meet many applications. The BDM's discharge wheel has six logarithmic shaped discharge arms which guarantee consistent feeding of any bulk material. The arms are bolted to a hub which is connected by a shrink disk to the output shaft of the reducer. Discharge arms are lined with wear resistant liner plates designed to increase the life of the discharge arms.

WTW's BDM is the industry standard for reliability in continuous operation.

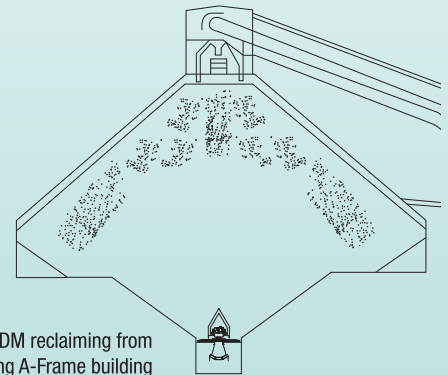

Block Model BDM reclaiming from 40m tall, 200m long A-Frame building

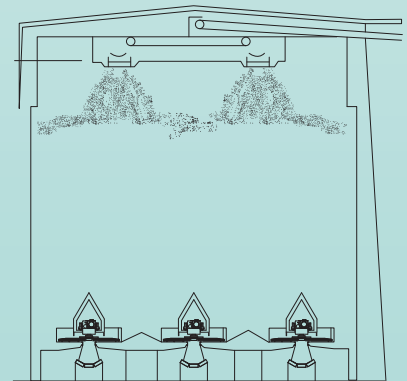

Reclaiming from large diameter silos or domes

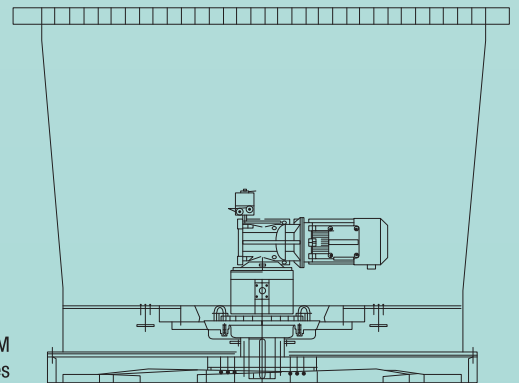

Stationary BDM unloading barges

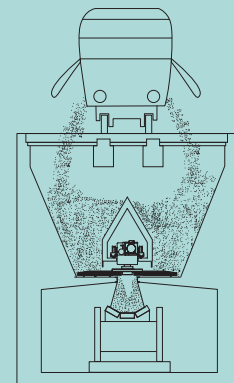

Rail car and truck receiving Block Model BDM

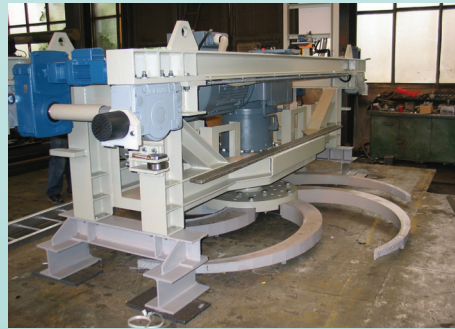
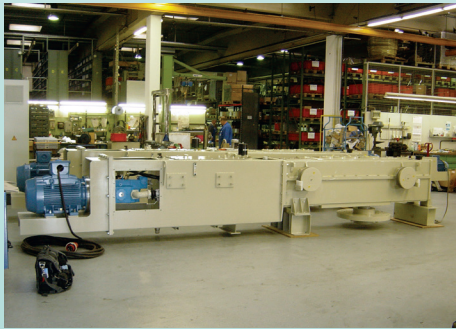

## Block - Technical Data

Discharge Capacity 5,0 ... 3,500 t/h

Diameter of discharge wheel D1 (mm)	L1 (mm)	L2 (mm)	L3 (mm)	L4 (mm)	H1 (mm)	H2 (mm)	H3 (mm)
2000	350	1300	700	500	1000	200	600
2500	450	1600	820	600	1100	250	775
3000	700	1600	820	600	1100	300	775
3500	850	1800	910	700	1150	350	950
4000	1000	2000	1000	800	1200	400	1030
4400	1100	2400	1200	1000	1200	440	1030
5000	1150	2700	1400	1200	1200	500	1030

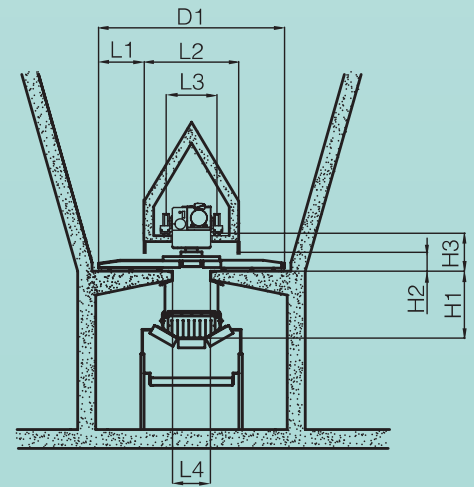

## Low profile - Technical Data

Discharge Capacity 2,5 ... 1,750 t/h

Diameter of discharge wheel D1 (mm)	L1 (mm)	L2 (mm)	L3 (mm)	L4 (mm)	H1 (mm)	H2 (mm)	H3 (mm)
2000	400	220	1500	250	1600	200	600
2500	450	240	1850	325	1650	250	650
3000	700	260	2200	400	1800	300	650
3500	800	280	2500	500	1900	350	700
4000	1000	300	2800	600	2000	400	750

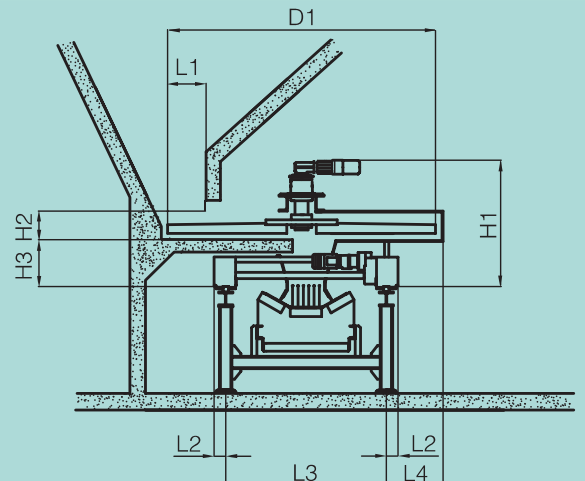

## Industries:

Gypsum  
Cement  
Power  
Alternative fuels  
Mining

Chemical  
Foundries  
Environmental protection  
Sludge & Waste handling

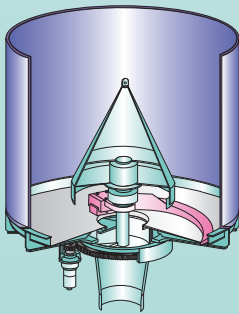

**BinEX**  
Rotary Bin Discharger

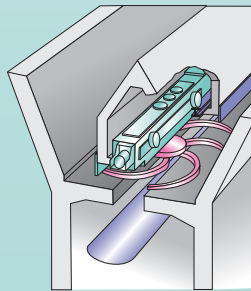

**BDM**  
Bunker Discharge Machine

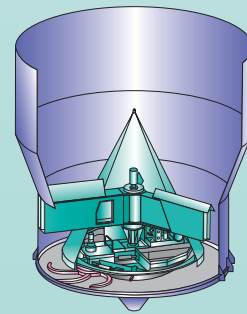

**PlanEX**  
Silo Discharger

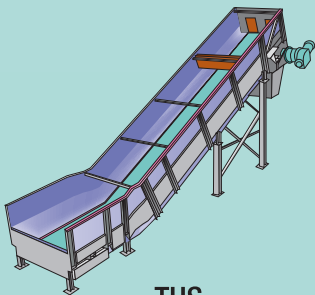

**TUS**  
Truck Unloading Station

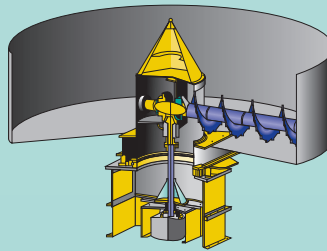

**Sweeping Auger**

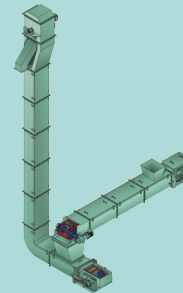

**Chain Conveyor**

WTW Americas Inc.

P.O. Box 1536, Stn. Main, Peterborough, ON Canada K9J 7H7

Phone. +1.705.749.3544 • Fax. +1.705.740.1775 • Email. [info@wtwamericas.com](mailto:info@wtwamericas.com) • [www.wtwamericas.com](http://www.wtwamericas.com)